

FUSE & CB CHART

FU/CB #	DESCRIPTION	FUSE TYP.	RATING	SIZE
110/120 VAC 1Ø 60HZ				
FU1	MAIN POWER	5 x 20mm	250 VAC	4A
FU2	MAIN POWER	5 x 20mm	250 VAC	4A
FU3	PS 24VDC	ATM / MINI	32 VDC	1A
208-250 VAC 1Ø 60HZ				
FU1	MAIN POWER	5 x 20mm	250 VAC	2A
FU2	MAIN POWER	5 x 20mm	250 VAC	2A
FU3	PS 24VDC	ATM / MINI	32 VDC	1A
SCCR	SHORT CIRCUIT CURRENT RATING 100KA			

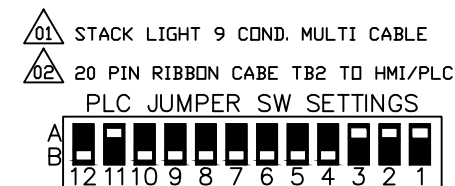

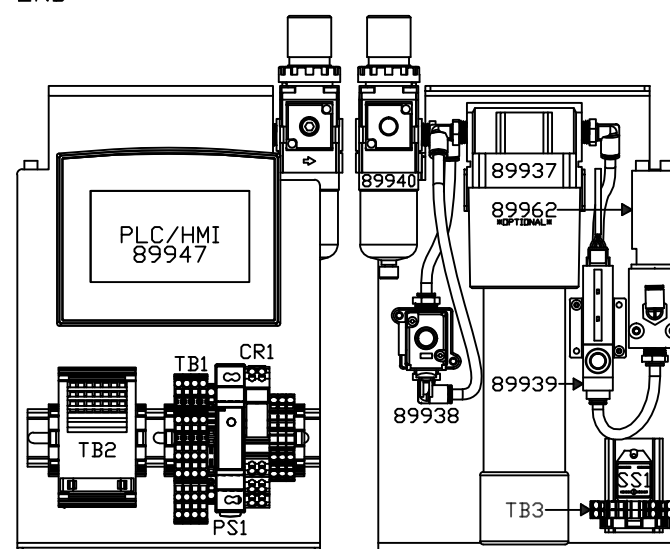

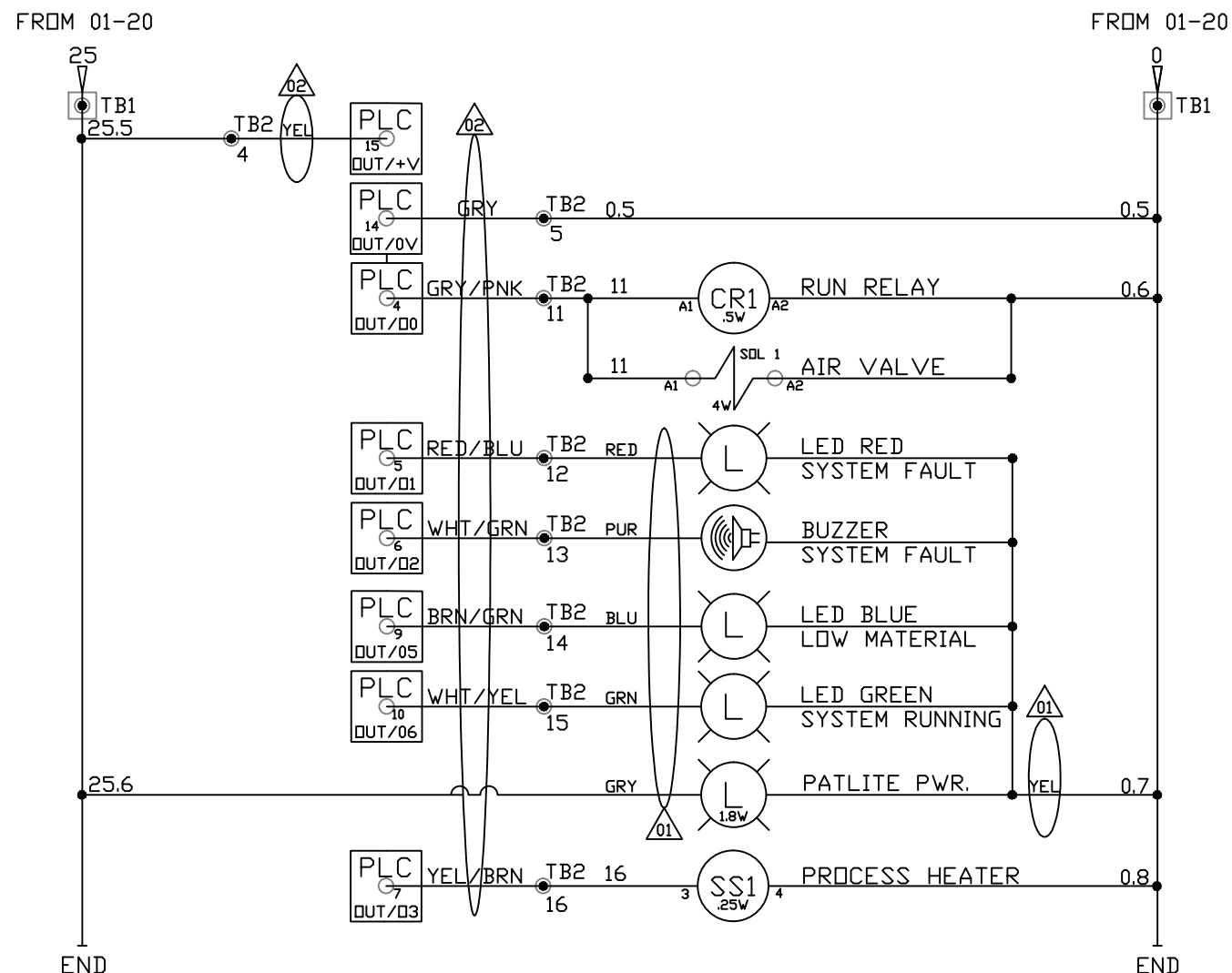
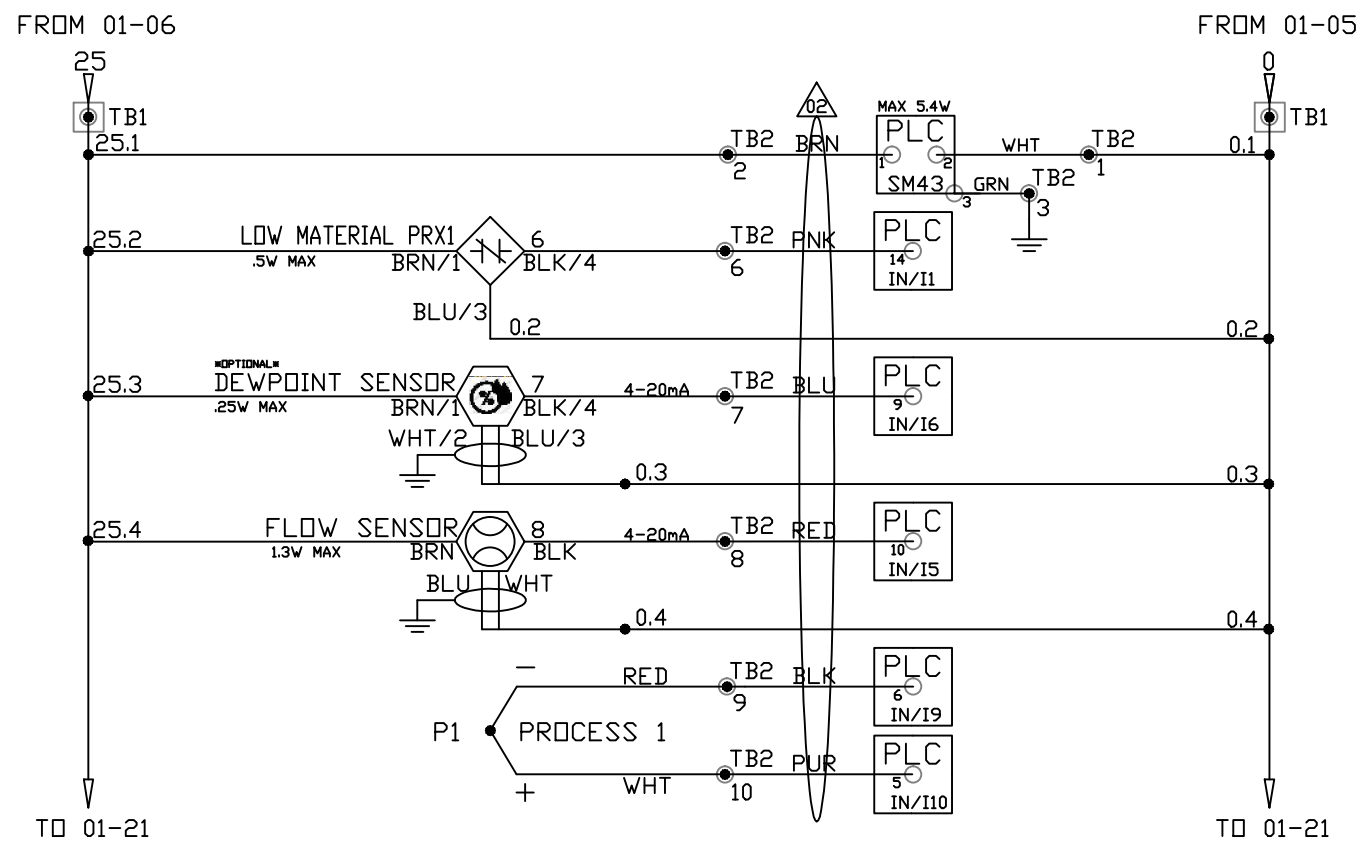

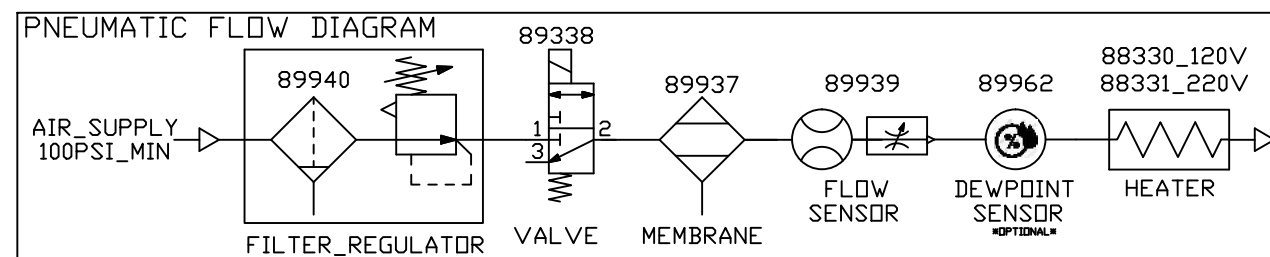









LEGEND

SYMBOL	DESCRIPTION
CR	CONTROL RELAY
FU	FUSE
GND	GROUND
HMI	HUMAN MACHINE INTERFACE
L	INDICATOR LIGHT
PLC	PROGRAMMABLE LOGIC CONTROLLER
PRX	PROXIMITY SWITCH
PS	POWER SUPPLY
RS	ROCKER SWITCH
SOL	SOLENOID
SS	SOLID STATE RELAY
TB	TERMINAL BLOCK

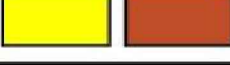

CUSTOMER:		S/N:	MD:
REV	DATE	BY	APP
DRI-AIR INDUSTRIES, INC.			
DRAWN	CHK'D	APP'D	DATE
KLVANA		JS	3/1/2024
TITLE MICRO DRYER MD1			
120/240 VAC 1Ø 60HZ			
SHEET	REV	DRAWING NO.	SIZE
1 OF 1	3	MD-1-1 & MD-1-2	B

This print property of Dri-Air Industries Inc. The information is submitted in confidence.

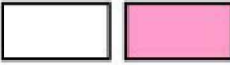
Color coding acc. to DIN VDE 47100		20-pole connector
		Contact number
white		1
brown		2
green		3
yellow		4
gray		5
pink		6
blue		7
red		8
black		9
violet		10
grey/pink		11
red/blue		12
white/green		13
brown/green		14
white/yellow		15
yellow/brown		16
white/grey		17
grey/brown		18
white/pink		19
pink/brown		20